

FlexiPole Connect (ES)

Quick Installation Guide

TOOLS



5 min

PARTS

x1

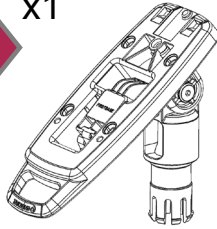

x1



x1

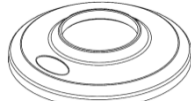

1

Remove original cover from stand

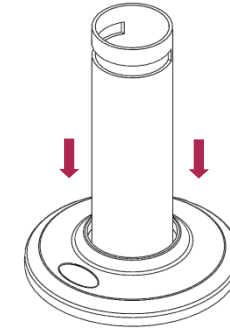
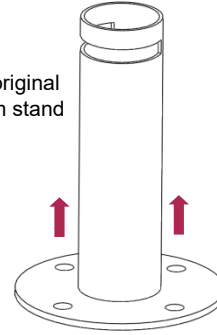

Slot new cover on to stand.

CHECK
Ensure logo on cover is facing forward. Must line up with slot in stand

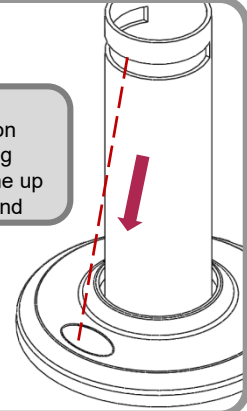

2

IMPORTANT !!
Part **MUST** be fitted with feature on plug facing rear of pole

REAR

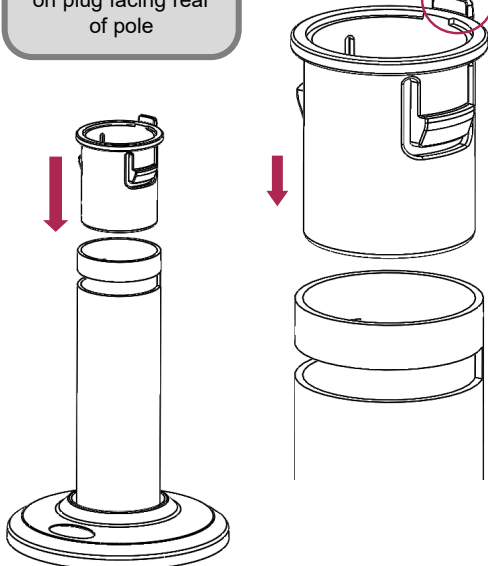

Position very important!
Check before fitting

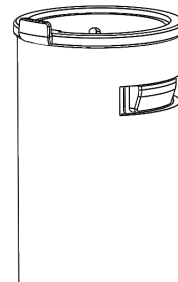

Must look like this

3

Slot Flexipole Connect into pole until click

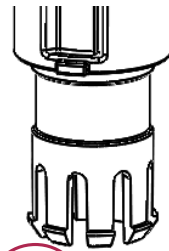

CLICK !!

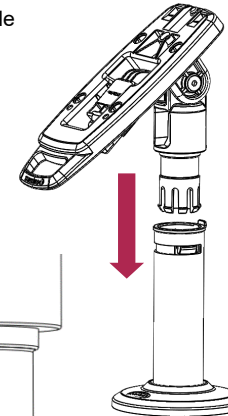

CHECK
Features **MUST NOT** be aligned or plinth will not slot into pole correctly

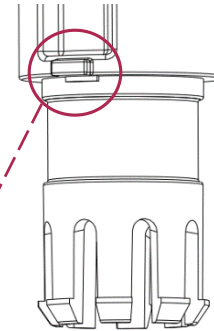

Plinth rotates in pole

